



DE Inhalator Gebrauchsanweisung	2	TR Inhalatör Kullanım kılavuzu	52
EN Nebuliser Instructions for use	12	RU Ингалятор Инструкция по применению.....	61
FR Inhalateur Mode d'emploi.....	21	PL Inhalator Instrukcja obsługi	71
ES Inhalador Manual de instrucciones.....	31		
IT Inalatore Istruzioni per l'uso.....	42		

Contents

1. Getting to know your instrument	12
2. Signs and symbols	12
3. Safety information and warnings	13
4. Description of device and accessories.....	14
5. Initial use.....	15
6. Operation.....	15
7. Changing the filter	16
8. Cleaning and disinfection	17
9. Disposal.....	18
10. Troubleshooting	18
11. Technical specifications	19
12. Replacement parts and wearing parts	20
13. Warranty/service.....	20

Included in delivery

For details of the delivery scope, see description of the device and accessories on page 14.

- Nebuliser
- Atomiser
- Compressed air hose
- Mouthpiece
- Adult mask
- Child mask
- Spare filter
- Storage bag
- These instructions for use

1. Getting to know your instrument

Dear customer

Thank you for choosing one of our products. Our name stands for high-quality, thoroughly tested products for applications in the areas of heat, weight, blood pressure, body temperature, pulse, gentle therapy, massage and air.

Please read these instructions for use carefully and keep them for later use, be sure to make them accessible to other users and observe the information they contain.

With kind regards
Your Beurer team

Area of application

This nebuliser is a device used for the nebulisation of liquids and liquid medication (aerosols) and for the treatment of the upper and lower respiratory tract. The nebulisation and inhalation of medication prescribed or recommended by a doctor can prevent against diseases of the respiratory tract, treat the side effects of these disorders and accelerate healing.

For more information on possible applications, consult your doctor or pharmacist.

The device is suitable for inhalation at home. Medicines should only be inhaled when instructed by a doctor. Inhalation should be performed in a calm and relaxed atmosphere. Inhale slowly and deeply to enable the medicine to reach the small bronchi deep into the lungs. Exhale normally.



Once prepared, the device is suitable for reuse. The preparation includes the replacement of all accessory parts including atomiser and air filter, as well as disinfection of the surfaces of the device with a standard disinfectant.

Please note that all accessories should be replaced if the device is used by more than one person.







We recommend that you replace the atomiser and other accessories after one year.

2. Signs and symbols

The following symbols appear in these instructions.

-  **Warning** Warning instruction indicating a risk of injury or damage to health.
-  **Important** Safety note indicating possible damage to the unit/accessory.
-  **Note** Note on important information.

The following symbols are used on the packaging and on the nameplate of the device and accessories.

	Type BF applied part
	Read the instructions for use
	Device in protection class 2
	Manufacturer
I	On
O	Off
	Serial number
20 Min. ON/ 40 Min. OFF	20 minute operation, followed by a 40 minute break before operation continues.
IP21	Protected against solid foreign objects 12.5 mm in diameter and larger, and against vertically falling drops of water
	The CE labelling certifies that the product complies with the essential requirements of Directive 93/42/EEC on medical products.



Dispose of packaging in an environmentally friendly manner

3. Safety information and warnings

Warning

- Before use, ensure that there is no visible damage to the unit or accessories. When in doubt, do not use the unit and contact your dealer or the customer service address provided.
- In the event of device faults, please see Chapter "10. Troubleshooting".
- Using the unit is not a substitute for consultation with or treatment from a physician. Whenever you have any pain or illness, always contact your physician first.
- If you have health concerns of any kind, contact your general practitioner!
- When using the atomiser, always follow the basic hygiene procedures.
- Always follow your doctor's instructions regarding the type of medicine to be used and the dose, frequency, and duration of inhalation.
- Only use medicines that have been prescribed or recommended by your doctor or pharmacist.

Please note:

For treatment, only use parts indicated by your doctor according to the particular diagnosis.

- Check whether there are contraindications for use with the usual systems for aerosol therapy on the medication instruction leaflet.
- If the unit does not function correctly or if you begin to feel unwell or feel pain, stop using the unit immediately.
- During use, hold the unit away from the eyes, as some nebulised medicines may cause damage to the eyes.
- Do not operate the unit in the presence of flammable gases.
- This device is not intended to be used by children or persons with restricted physical, sensory (e.g. insensitivity to pain) or mental abilities or persons lacking in the required experience or knowledge for safe operation of the device, unless supervised or instructed by a person responsible for their safety.
- Check in the medicine package leaflet for possible contraindications for use with common aerosol therapy systems.
- The device must be switched off and the plug pulled out before every cleaning and/or maintenance procedure.
- Keep children away from packaging materials (risk of suffocation).
- To avoid the risk of entanglement and strangulation, store cables and air lines out of the reach of small children.

- Do not use attachments that are not recommended by the manufacturer.
- Connect the unit only to the mains voltage listed on the type plate.
- Do not dip the unit into water and do not use it in wet rooms. Do not allow any liquid to penetrate the unit.
- Protect the unit from strong impacts.
- Never touch the mains cable with wet hands, this can cause an electric shock.
- Do not pull the mains plug from the socket by the cord.
- Do not pinch or bend the mains cable, pull it over sharp objects, or allow it to hang freely, and protect it against sources of heat.
- We recommend that the power cable is completely unrolled to avoid dangerous overheating.
- If the mains connection cable of this device is damaged, it must be disposed of. If it cannot be removed, the device must be disposed of.
- Opening the unit carries a risk of electric shock. Disconnection from the mains supply is only guaranteed if the mains plug has been removed from the socket.
- Do not use the unit if it has fallen or been dropped on the floor, been exposed to extreme humidity or is otherwise damaged. In case of doubt, contact our customer service department or your local dealer.
- The IH 18 nebuliser must only be used with suitable atomisers and with the appropriate accessories. The use of other atomisers and accessories can impair therapeutic efficiency and may damage the device.

Important

- Power cuts, sudden faults or other unfavourable conditions may render the unit unusable. You are therefore recommended to keep a spare device or replacement medicine (as agreed with the doctor).
- If adapters or extensions are required, these must comply with the applicable safety regulations. The electrical capacity and the maximum capacity specified on the adapter must not be exceeded.
- The unit and the mains cable must be stored away from sources of heat.
- Do not use the unit in a room in which a spray has previously been used. If this is the case, ventilate the room before commencing treatment.
- Do not allow any objects to enter or obstruct the ventilation openings.
- Do not use the device if you notice an unusual noise.
- For hygiene reasons, each user must use his own accessories.
- Always disconnect from the mains after use.
- Store the device in a location protected against environmental influences. The device must be stored in the specified ambient conditions.

FUSE

- The device contains an overload protection fuse. This must only be changed by authorised specialist personnel.

General notes

⚠ Important

- Use the unit only:
 - On humans,
 - for its intended purpose (aerosol inhalation) and in the manner described in these instructions for use.
- **Any improper use can be dangerous!**
- In acute emergencies, first aid takes priority.
- Apart from the medication, use only distilled water or a saline solution in the unit. Other liquids may cause defects to the nebuliser or atomiser.
- This unit is not intended for commercial or clinical use, but only for individual, private household use!

Before using the unit for the first time

⚠ Important

- Before you use the unit for the first time, remove all packaging materials.
- Protect the unit against dust, dirt and moisture. Never cover the unit during operation.
- Do not use the unit in very dusty environments.
- Switch the unit off immediately if it is defective or malfunctioning.
- The manufacturer shall not be held liable for damage or injuries caused by improper or incorrect use.

Repairs

ⓘ Note

- Never open or attempt to repair the unit yourself, as otherwise proper function is no longer guaranteed. Failure to observe this regulation shall void the warranty.
- If you need to have the unit repaired, contact customer service or an authorised dealer.
- The device is maintenance-free.

4. Description of device and accessories

Overview of the nebuliser

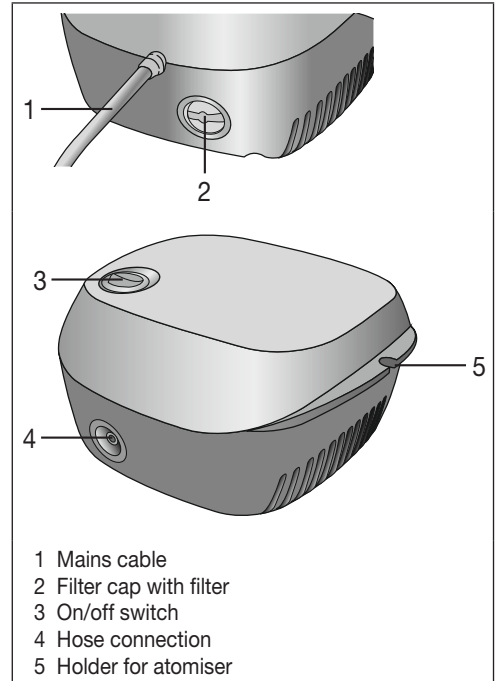

Overview of atomiser and accessories

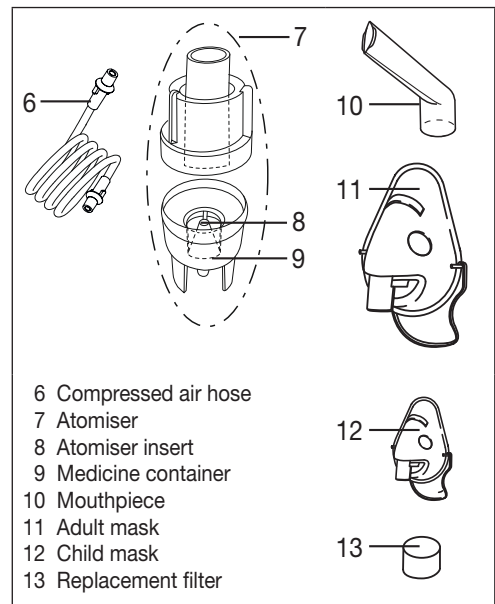

5. Initial use

Setup

Remove the unit from the packaging. Place it on a flat surface.

Ensure that the ventilation slits are free.

Before using the unit for the first time

Note

- The atomiser and accessories must be cleaned and disinfected before they are used for the first time. For information about this, see “Cleaning and disinfection” on page 17.
- Attach the compressed-air hose [6] at the bottom of the medicine container [9].

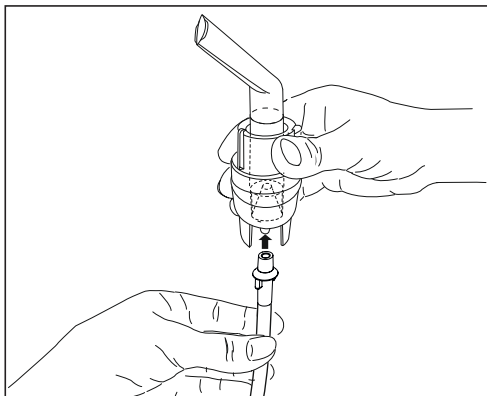

- Connect the other end of the hose [6] to the hose connector [4] on the nebuliser by lightly turning it.

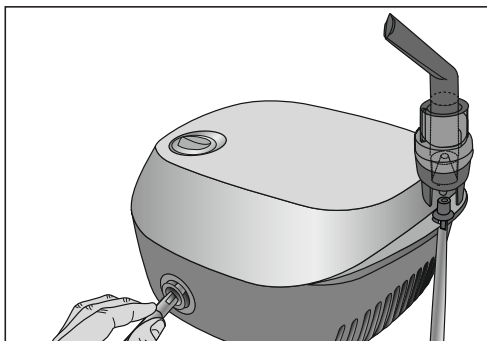

Mains connection

Connect the unit only to the mains voltage listed on the type plate.

- Insert the mains cable plug [1] into a suitable socket.
- Push the plug completely into the mains socket.

Note

- Ensure that there is a socket near to where the unit will stand.

- Lay the mains cable in such a way that no one can trip over it.
- To disconnect the nebuliser from the mains after use, first switch off the device and then remove the plug from the socket.

6. Operation

Caution

- For hygiene reasons, the atomiser [7] and the accessories must be cleaned after each treatment and disinfected after the last treatment of the day.
- The accessories may be used only by one person; use by several people is not recommended.
- If several different medicines are to be inhaled in succession during therapeutic use, the atomiser [7] must be rinsed under warm tap water after each use. For information about this, see “Cleaning and disinfection” on page 17.
- Follow the instructions for changing the filter contained in these instructions.
- Before each use, check that the hose connections on the nebuliser [4] and the atomiser [7] are tight.
- Before use, check that the device is functioning correctly. To do this, switch on the nebuliser (including the connected atomiser, but without any medication) for a short time. If the atomiser [7] expels air, the device is functioning correctly.

1. Inserting the nozzle attachment

- To open the atomiser [7], twist the upper section anti-clockwise against the medicine container [9]. Place the nozzle attachment [8] in the medicine container [9].
- Ensure that the cone for administering medication fits well on the cone for the air duct inside the atomiser [7].

2. Filling the atomiser

- Pour an isotonic saline solution or the medicine directly into the medicine container [9]. Do not overfill! The maximum recommended fill level is 6 ml!
- Use medication only on the advice of a physician, and check the appropriate inhalation duration and quantity for your needs.
- If the required volume of medication is less than 2 ml, top up this quantity to at least 4 ml using an isotonic saline solution. Viscous medicines may also require dilution. Always follow the instructions of your doctor.

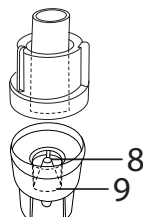

3. Closing the atomiser

- To close the atomiser [7], twist the upper section clockwise against the medicine container [9]. Ensure the parts are connected correctly.

4. Connecting the accessories to the atomiser

- Connect the required accessory part (mouthpiece [10], adult mask [11] or child mask [12]) to the atomiser [9].

In addition to the accompanying adult [11] and children's mask (from 2 years of age) [12], you also have the option of using baby mask (from ages 0-3 years) with your nebuliser. The baby mask is not included in delivery with the IH 18. You can find an overview of all replacement items in chapter "12. Replacement parts and wearing parts".

Note

The most effective form of nebulisation is by using the mouthpiece. Nebulisation using a mask is only recommended if it is not possible to use a mouthpiece (e.g. for children who are not yet able to inhale medication using a mouthpiece).

When using a mask to inhale, take care to ensure the mask fits well and the eyes are unobstructed.

- Before commencing treatment, pull the atomiser upwards out of its holder [7].
- Start the nebuliser using the on/off switch [3].
- A flow of spray from the atomiser indicates that the device is functioning properly.

5. Treatment

- When inhaling, sit upright and relaxed at a table and not in an armchair to avoid compressing the airways and therefore impairing the effectiveness of the treatment.
- Inhale the nebulised medicine deeply.

Important

The device is not suitable for continuous operation; after 20 minutes of operation it must be switched off for 40 minutes.

Note

During treatment, hold the atomiser straight (vertical), otherwise the atomisation does not work and correct function cannot be guaranteed.

Important

Essential oils, cough medicines, solutions designed for gargling, and drops for application to the skin or for use in steam baths are wholly unsuitable for inhalation using a nebuliser. These substances are often highly viscous and can impair the correct function of

the device and hence affect the effectiveness of its application in the long term.

In the case of oversensitivity of the bronchial system, medicines containing essential oils can sometimes cause acute bronchospasm (a sudden, cramp-like tightening of the bronchi accompanied by breathlessness). Always ask your doctor or pharmacist for advice!

6. End of inhalation

If the spray is only output sporadically or if the noise changes during inhalation, you can end the treatment.

- Switch off the nebuliser after treatment using the on/off switch [3] and disconnect it from the mains.
- After use, replace the atomiser [9] in its holder [7].

7. Clean the device

For information about this, see "Cleaning and disinfection" on page 17.

7. Changing the filter

In normal operating conditions, the air filter must be replaced after approx. 500 operating hours or one year. Please check the air filter regularly (after 10-12 nebulisation procedures).

If the filter is very contaminated or blocked, replace the used filter. If the filter has become wet, it must also be replaced with a new one.

Caution

- Do not try to clean and re-use the used filter!
- Only use original filters supplied by the manufacturer. Otherwise, your nebuliser may become damaged or effective therapy can no longer be guaranteed.
- Do not repair or maintain the air filter while it is in use.
- Never operate the device without a filter.

To replace the filter, proceed as follows:

Caution

- First switch off the unit and unplug it.
- Allow the unit to cool down.

1. Remove filter cap [2] upwards.

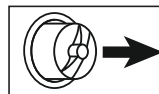

Note

If the filter remains in the unit when the cap is removed, remove the filter from the unit using tweezers or similar.

2. Replace the filter cap [2] containing the new filter.
3. Check that the filter cap is firmly in place.

8. Cleaning and disinfection

Atomiser and accessories

Warning

Observe the following hygiene instructions in order to avoid any health risks.

- The atomiser [7] and accessories are intended for multiple use. Please note that cleaning requirements differ according to the different application areas.

Notes:

- The atomiser and accessories must not be mechanically cleaned with brushes or similar as this can cause irreparable damage and the success of the treatment can no longer be guaranteed.
- For additional requirements regarding the necessary hygienic preparations (hand washing, handling of medicines or inhalation solutions) in high-risk groups (e.g. cystic fibrosis patients), contact your doctor.
- Ensure that all parts are properly dried following all cleaning and disinfection. Residual moisture or water droplets can result in an increased risk of bacterial growth.

Preparation

- Directly following each treatment, all parts of the atomiser [7] and any accessories used must be cleaned of medicine residues and contamination.
- To do this, dismantle the atomiser [7] into its component parts.
- Remove the mouthpiece [10] from the atomiser.
- Dismantle the atomiser by twisting the upper section anti-clockwise against the medicine container [9].
- Remove the nozzle attachment [8] from the medicine container [9].
- The nebuliser is later reassembled in the reverse order.

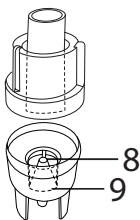

Cleaning

Important

Before you clean the unit, always switch it off, unplug it and let it cool off.

The **atomiser** and the used **accessories** such as the mouthpiece, mask, nozzle attachment, etc. must be washed with hot but not boiling water after each use. Carefully dry all components using a soft cloth. Once all components are fully dry, reassemble the atomiser and place the components in a dry, sealed container or carry out disinfection.

When cleaning, ensure that all residues are removed. Never use any substances that may be poisonous

when in contact with the skin or mucous membranes, or when swallowed or inhaled.

Use a soft, dry cloth and non-abrasive cleaning products to clean the **device**.

Do not use abrasive detergents and never immerse the unit in water.

Important

- Ensure that no water penetrates inside the unit!
- Do not put the device or accessories in a dishwasher.
- Do not touch the unit with wet hands while it is plugged in; do not allow any water to be sprayed onto the unit. The unit must be operated only when it is completely dry.
- Do not spray any liquids into the ventilation slots. Any liquid that penetrates into the unit can damage the electrical parts or other components of the nebuliser and impair the function of the device.

Condensation, care of the hose

Depending on the environmental conditions, condensation may collect in the hose. To prevent against bacterial growth and to ensure effective therapeutic use, this moisture must always be removed. To remove moisture from the hose, proceed as follows:

- Remove the hose [6] from the atomiser [7].
- Leave the hose plugged into the nebuliser [4].
- Run the nebuliser until all the moisture has been displaced by the flow of air.
- In the event of significant contamination, replace the hose.

Disinfection

Follow the steps listed below carefully in order to disinfect your atomiser and the accessories. It is advisable to disinfect the individual components after the last time they are used each day at the latest.

(For disinfection, you will simply require a small amount of clear vinegar and distilled water).

- First clean the atomiser and the accessories as described under "Cleaning".
- Place the disassembled **atomiser** and **mouthpiece** in boiling water for 5 minutes.
- For the remaining accessories, use a vinegar solution consisting of $\frac{1}{4}$ vinegar and $\frac{3}{4}$ distilled water. Make sure that the volume is sufficient to fully submerge the parts in the solution.
- Leave the components in the vinegar solution for 30 minutes.
- Rinse the parts with water and dry carefully with a soft cloth.

Important

Do not boil or autoclave the masks and air hose.

- Once all components are fully dry, reassemble the atomiser and place the components in a dry, sealed container.

Note

Ensure that all parts are thoroughly dried during, and in particular after cleaning, otherwise there is an increased risk of bacterial growth.

Drying

- Place the individual components on a dry, clean and absorbent surface and allow to dry completely (for at least 4 hours).

Material resistance

- As with all plastic components, frequent use and cleaning of the atomiser and the accessories can lead to a certain amount of wear. Over time, this can alter the aerosol properties and may eventually affect the efficiency of therapy. We therefore recommend that you replace the atomiser once a year.
- When choosing a cleaning or disinfecting agent, note the following: Only use mild cleaning or disinfectant agents in the quantities recommended by the manufacturer.

Storage

- Do not store the nebuliser in a damp atmosphere (e.g. in the bathroom) or transport it together with damp objects.
- Store and transport the nebuliser away from direct sunlight.
- Store the device in a dry place, if possible in its original packaging.

9. Disposal

In the interest of environmental protection, do not dispose of the device in household waste. Please dispose of the device in accordance with EC Directive – **WEEE** (Waste Electrical and Electronic Equipment).



If you have any queries, please contact the appropriate local authorities.

10. Troubleshooting

Problem/Question	Possible Cause/Remedy
The atomiser produces little or no aerosol.	1. Too much or too little medicine in the atomiser. Minimum: 2 ml, Maximum: 8 ml.
	2. Check that the nozzles are not blocked. If necessary, clean the nozzle (e.g. by rinsing). Use the atomiser again. CAUTION: Only poke implements through the fine holes from the underside of the nozzle.
	3. The atomiser is not held in an upright position.
	4. The medicine solution is unsuitable for nebulising (e.g. too thick). The medicine solution should be specified by the doctor.
Output is too low.	Hose kinked, filter blocked, too much inhalation solution.
Which medicines are suitable for inhalation?	Consult your doctor. Essentially all medicines that are suitable and approved for device-based inhalation can be inhaled.
Some inhalation solution remains in the atomiser.	This is normal and occurs for technical reasons. Stop inhalation if you hear a notable difference in the noise of the atomiser.
What special steps should be taken for babies and children?	1. In babies, the mask should cover the mouth and nose to guarantee effective inhalation. 2. In children, the mask should also cover the mouth and nose. Nebulisation next to a sleeping person is not suitable because insufficient medicine reaches the lungs. Note: Children should only use the device with help and under supervision of an adult. Never leave a child alone with the nebuliser.
Inhalation with the mask takes longer.	This is for technical reasons. Less medicine is inhaled per breath through the mask holes than using the mouthpiece. The aerosol is mixed with ambient air through the holes in the mask.

Problem/Question	Possible Cause/Remedy
Why do I need to replace the atomiser at regular intervals?	There are two reasons for this: 1. To guarantee a therapeutically effective particle spectrum, the nozzle holes should not exceed a certain diameter. Due to the thermal and mechanical stresses, the plastic is subjected to a certain amount of wear. The nozzle attachment [8] is particularly susceptible to this wear. This can also cause changes to the droplet composition of the aerosol, which has a direct effect on the effectiveness of the treatment. 2. You are also recommended to replace the atomiser on a regular basis for hygiene reasons.
Does each person need their own atomiser?	This is absolutely necessary for hygiene reasons.

Aerosol Properties	Flow: 5.31 l/min Aerosol delivery: 0.171 ml Aerosol delivery rate: 0.082 ml/min Particle size (MMAD): 3.16 µm
--------------------	--

The serial number is located on the device or in the battery compartment.

Subject to technical modifications.

Particle size diagram

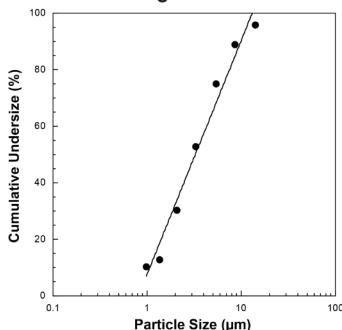

Measurements were performed using a sodium fluoride solution with a "Next Generation Impactor" (NGI). This diagram may not be applicable for suspensions or highly viscous medicines. More information can be obtained from the relevant medicine manufacturer.

11. Technical specifications

Model	IH 18
Type	IH 18/1
Dimensions (WxHxD)	160 x 155 x 84 mm
Weight	1.3 kg
Operating pressure	approx. 0.8 – 1.45 bar
Atomiser fill volume	min. 2 ml max. 8 ml
Medicine flow	ca. 0.4 ml/min
Sound pressure	approx. 52 dBA (acc. to DIN EN 13544-1 section 26)
Mains connection	230 V~, 50 Hz; 230 VA UK: 240 V~; 50 Hz; 240 VA
Expected service life	1000 h
Operating conditions	Temperature: +10 °C – +40 °C Relative humidity: 10% – 95% Atmospheric pressure: 700 hPa – 1060 hPa
Storage and transport conditions	Temperature: 0 °C – +60 °C Relative humidity: 10% – 95% Atmospheric pressure: 500 hPa – 1060 hPa

Note

If the unit is used outside of the specifications, proper function is no longer guaranteed!

We reserve the right to make technical changes to improve and further develop the product.

This device and its accessories comply with European standards EN60601-1 and EN60601-1-2 (CISPR 11, IEC 61000-3-2, IEC 61000-3-3, IEC 61000-4-2, IEC 61000-4-3, IEC 61000-4-4, EC 61000-4-5, IEC 61000-4-6, IEC 61000-4-7, IEC 61000-4-8, IEC 61000-4-11), as well as EN13544-1, and is subject to special safety measures in terms of electromagnetic tolerance. The unit conforms to the requirements of the European Directive for Medical Products 93/42/EEC, the MPG (German Medical units Act).

Notes on electromagnetic compatibility

- The device is suitable for use in all environments listed in these instructions for use, including domestic environments.
- The use of the device may be limited in the presence of electromagnetic disturbances. This could result in issues such as error messages or the failure of the display/device.

- Avoid using this device directly next to other devices or stacked on top of other devices, as this could lead to faulty operation. If, however, it is necessary to use the device in the manner stated, this device as well as the other devices must be monitored to ensure they are working properly.
- The use of accessories other than those specified or provided by the manufacturer of this device can lead to an increase in electromagnetic emissions or a decrease in the device's electromagnetic immunity; this can result in faulty operation.
- Failure to comply with the above can impair the performance of the device.

If the buyer wishes to make a warranty claim, they should approach their local retailer in the first instance: see the attached "International Service" list of service addresses.

The buyer will then receive further information about the processing of the warranty claim, e.g. where they can send the product and what documentation is required.

A warranty claim shall only be considered if the buyer can provide Beurer, or an authorised Beurer partner, with

- a copy of the invoice/purchase receipt, and
- the original product.

The following are explicitly excluded from this warranty:

- deterioration due to normal use or consumption of the product;
- accessories supplied with this product which are worn out or used up through proper use (e.g. batteries, rechargeable batteries, cuffs, seals, electrodes, light sources, attachments and nebuliser accessories);
- products that are used, cleaned, stored or maintained improperly and/or contrary to the provisions of the instructions for use, as well as products that have been opened, repaired or modified by the buyer or by a service centre not authorised by Beurer;
- damage that arises during transport between manufacturer and customer, or between service centre and customer;
- products purchased as seconds or as used goods;
- consequential damage arising from a fault in this product (however, in this case, claims may exist arising from product liability or other compulsory statutory liability provisions).

Repairs or an exchange in full do not extend the warranty period under any circumstances.

12. Replacement parts and wearing parts

Replacement parts and wearing parts are available from the corresponding listed service address under the stated material number.

Designation	Material	REF
Yearpack (contains Mouth-piece, Adult mask, Child mask, Atomiser, Compressed air hose, Filter)	PP/PVC	601.21
Baby mask	PVC	601.31

13. Warranty/service

Beurer GmbH, Söflinger Straße 218, 89077 Ulm, Germany (hereinafter referred to as "Beurer") provides a warranty for this product, subject to the requirements below and to the extent described as follows.

The warranty conditions below shall not affect the seller's statutory warranty obligations which ensue from the sales agreement with the buyer.

The warranty shall apply without prejudice to any mandatory statutory provisions on liability.

Beurer guarantees the perfect functionality and completeness of this product.

The worldwide warranty period is 5 years, commencing from the purchase of the new, unused product from the seller.

The warranty only applies to products purchased by the buyer as a consumer and used exclusively for personal purposes in the context of domestic use.

German law shall apply.

During the warranty period, should this product prove to be incomplete or defective in functionality in accordance with the following provisions, Beurer shall carry out a repair or a replacement delivery free of charge, in accordance with these warranty conditions.